

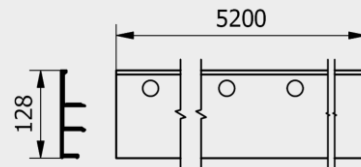

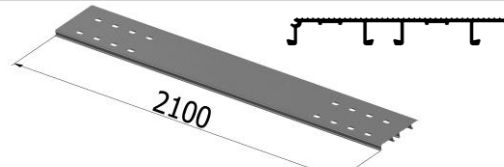





Nazwa produktu: **Zestaw montażowy lawety LIGHT**

Nr kat.: **18ZL22005200**

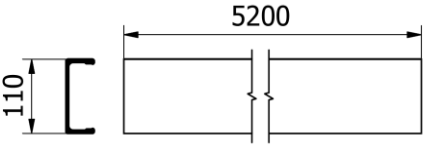
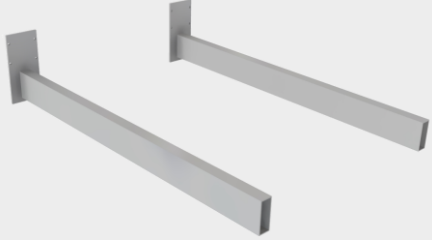
Nr poz.	Nr kat.	Nazwa	ilość	UWAGI	Grafika
1.	22.21.4489	Profil obwodowy lawetowy LIGHT otworowany	2	profil otworowany L=5200mm - 50 otworów	
2.	18PP350210016ALU	Panel podłogowy L=2100, 16 otworów	20	otwory zgodne z klinem 18KL125	
3.	22.21.88168	Profil najazdowy zakończeniowy 120	1	długość L=2100mm	
4.	18BAS781391171	Zestaw osłony kabiny LIGHT	1	kpl wg. specyfikacji	

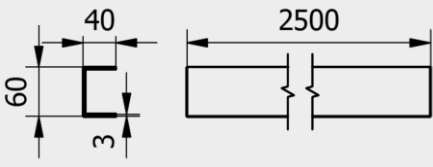
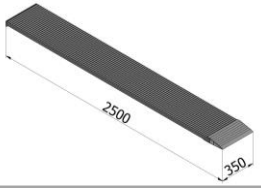
Nazwa produktu: **Zestaw montażowy lawety LIGHT**

Nr kat.: **18ZL22005200**

Nr poz.	Nr kat.	Nazwa	ilość	UWAGI	Grafika
5.	22.21.770	Profil pomocniczy ramy 110 mm	2	długość L=5200mm	
6.	181305015	Zestaw przedłużenia ramy	1	kpl wg. specyfikacji	
7.	182100245	zestaw zderzaka lawety	1	kpl wg. specyfikacji	
8.	22.21.60403	Ceownik aluminiowy 60x40x3	4	przewodzenie najazdów L=2500mm	
9.	184NAL233040	Najazd aluminiowy L=2330 + dziubek nitowany	2	łącna długość L=2480	
10.	18302100	Blokada najazdu lawety kpl.	1	kpl wg. specyfikacji	
11.	6ZG9825 L	Zaślepka gumowa zakończenia najazdu lewa	1		
12.	6ZG9825 P	Zaślepka gumowa zakończenia najazdu prawa	1		

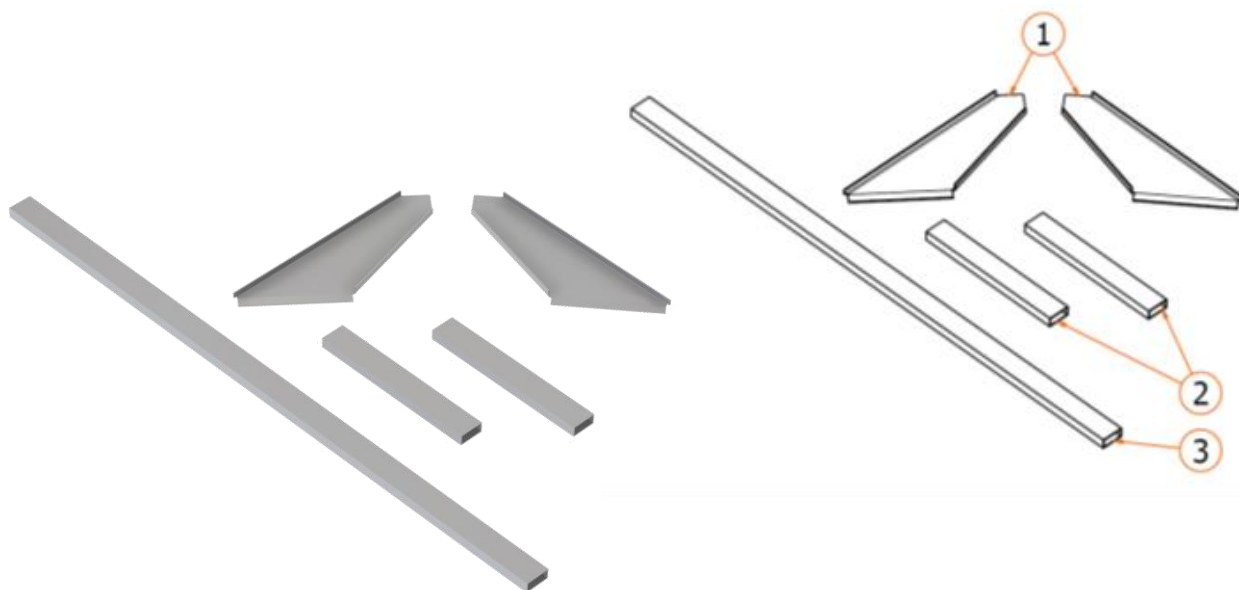

Nazwa produktu:  
**Zestaw osłony kabiny LIGHT**

Nr karty:  
**18BAS781391171**

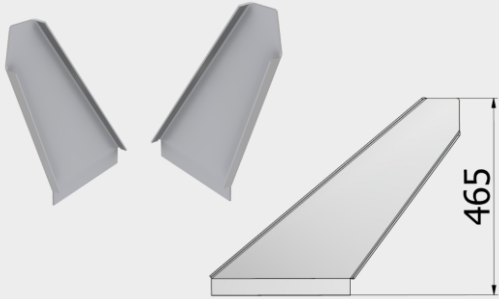
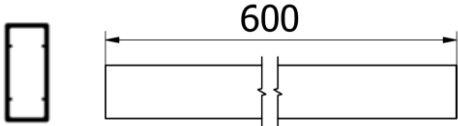
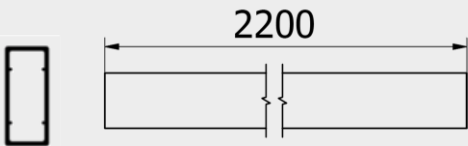
Nr poz.	Nr kat.	Nazwa	ilość	UWAGI	Grafika
1.	18BZK.1	Błacha boczna osłony kabiny Light	2	lewa + prawa wg. dok. waga 1,48kg/szt	
2.	22.22.4281	Profil 80 x 35	2	długości L=600mm	
3.	22.22.4281	Profil 80 x 35	1	długości L=2200mm	

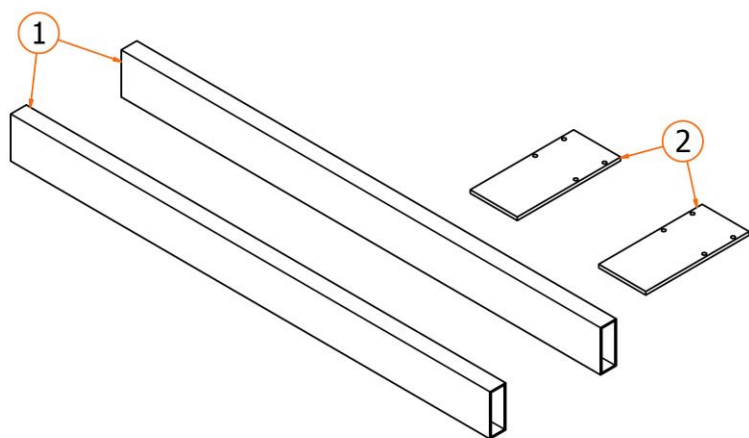
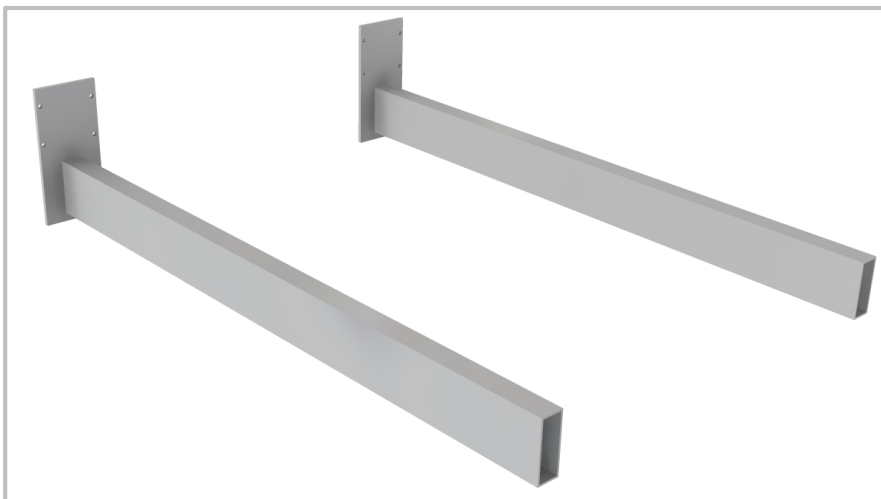

Nazwa produktu: **Zestaw przedłużenia ramy**



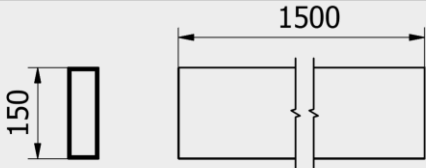
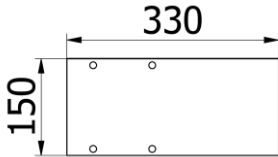

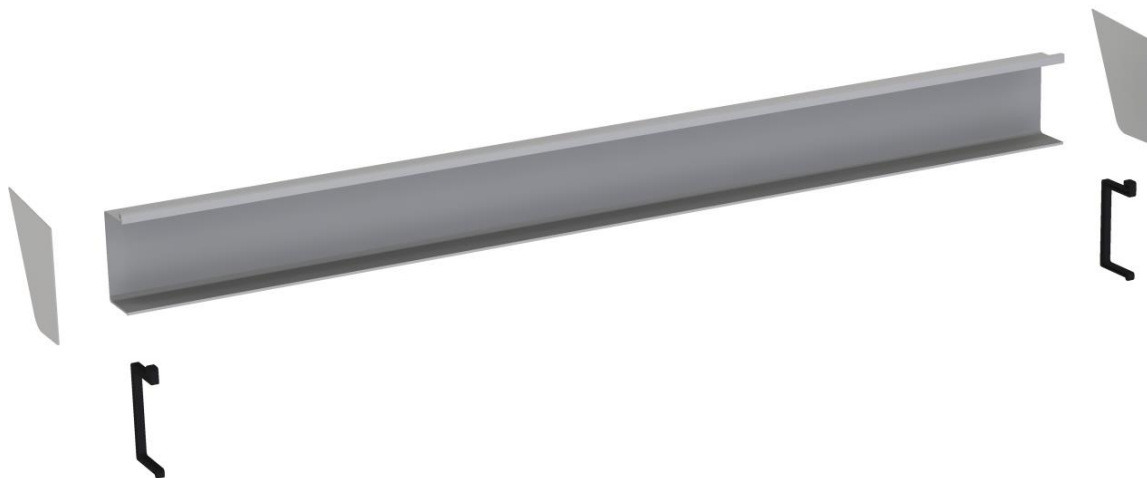
Nr karty: **181305015**

Nr poz.	Nr kat.	Nazwa	ilość	UWAGI	Grafika
1.	22.21.150504	Profil przedłużenia ramy 150 x 50 x 4	2	długości = 1500mm	
2.	18BMR33015010 ALU	Błacha mocująca ramę	2	wg. dok.	



Nazwa produktu: **Zestaw zderzaka lawety**

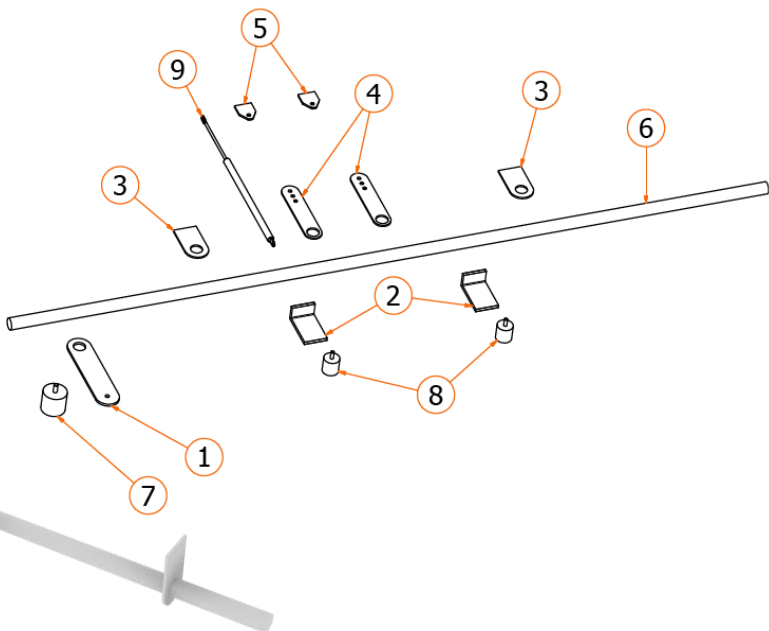

Nr karty: **182100245**

Nr poz.	Nr kat.	Nazwa	ilość	UWAGI	Grafika
1.	18ZA2100ALU	Zderzak tylny lawety	1	długości = 2100mm	
2.	18BZZ3342284ALU	Błacha boczna zderzaka lawety	2		
3.	6ZG201101 L	Zaślepka gumowa zakończenia profilu zderzaka	1	lewa	
4.	6ZG201101P		1	prawa	

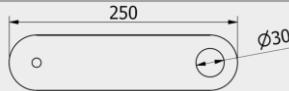
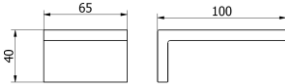
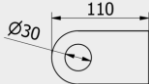
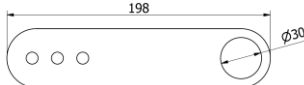
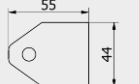
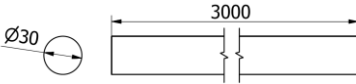
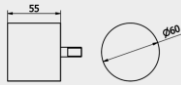
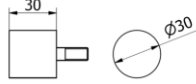

Nazwa produktu: **Blokada najazdu lawety kpl.**

Nr kat.: **18302100**

Nr poz.	Nr kat.	Nazwa	ilość	UWAGI	Grafika
1.	18DBN250606 ALU	Dźwignia blokady najazdów assistance	1	wg. dok	
2.	18KMO40ALU	Kątownik mocowania odbojnika fi 40	2	kątownik 100x100x8 L=65mm	
3.	18PMP110604 ALU	Płaskownik mocowania pręta fi 30	2	wg. dok	
4.	18PZZ200444 ALU	Płaskownik mocowania siłownika assistance	2	wg. dok	
5.	18PZZ200445 ALU	Ucho mocowania siłownika	2	wg. dok	
6.	22.21.30	Pręt aluminiowy fi 30	1	długości L=3000mm	
7.	60G5055	Odbojnik gumowy fi 60x55 M10	3		
8.	60G3030	Odbojnik gumowy fi 30x30 M8	4		
9.	PRO.SG160/500	Sprężyna gazowa 160mm/500 N	1	KROSNO	
10.	Normalia	Nakrętka samokontrolująca M10	3	DIN 985	
11.	Normalia	Nakrętka samokontrolująca M8	6	DIN 985	
12.	Normalia	Podkładka M10	3	DIN 125	
13.	Normalia	Podkładka M8	8	DIN 125	
14.	Normalia	Śruba imbusowa łeb walcowy M8x50	2	DIN 912	

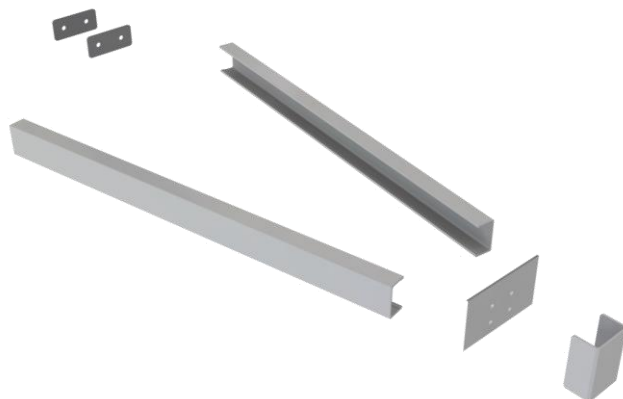
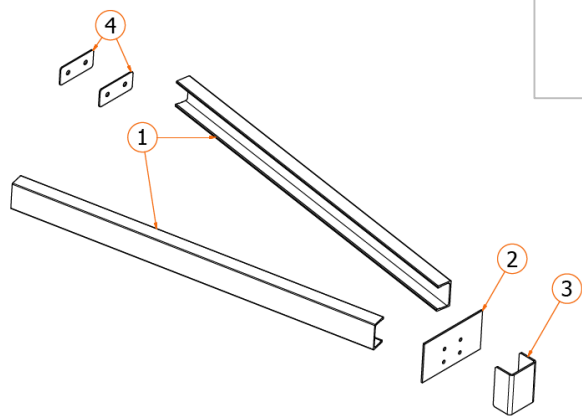
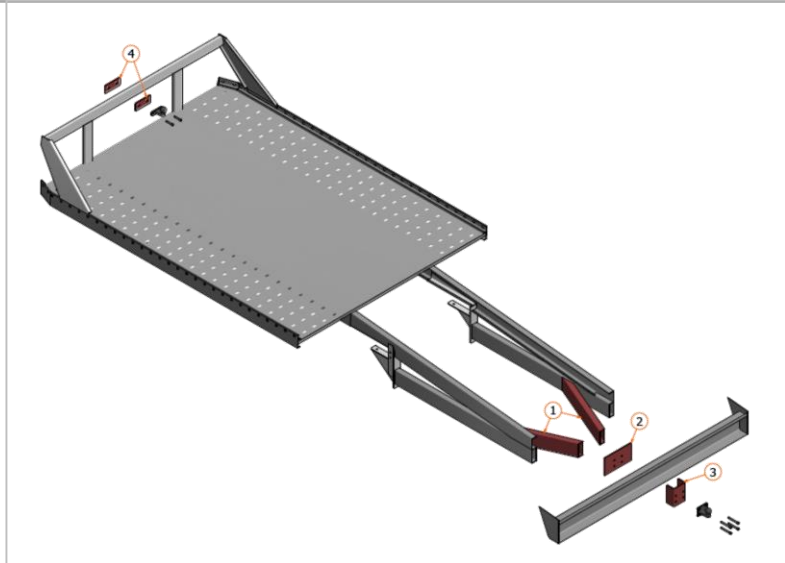

Nazwa produktu: **Zestaw wzmocnień haka lawety**  
(wyposażenie opcjonalne)

Nr karty: **181500110**

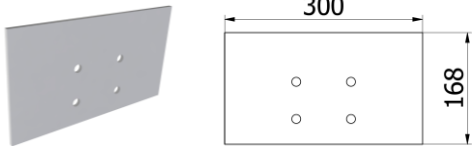
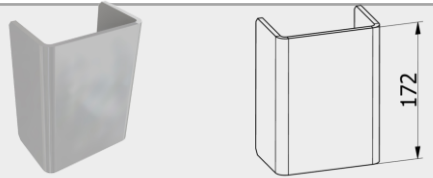
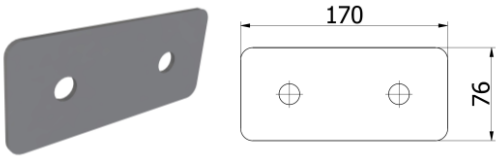
Nr poz.	Nr kat.	Nazwa	ilość	UWAGI	Grafika
1.	22.21.770	Profil pomocniczy ramy 110 mm	2		
2.	18WH.1	Płyta wzmocnienia zderzaka tylnego	1		
3.	22.21.833	profil C130	1		
4.	18PZK.1	Płyta wzmocnienia osłony kabiny	2		

## Notatki

**PROFILPOL**  
-----  
SYSTEM



OLEŚNO  
ul. Częstochowska 20  
46-300 Olesno



[www.profilpolsystem.pl](http://www.profilpolsystem.pl)



[sprzedaz@profilpolsystem.pl](mailto:sprzedaz@profilpolsystem.pl)



+48 883 335 994

